

B5WC

Color Sensor to Build into Equipment

Reliable Detection of Changes and Differences in Color – Contributes to Automation of Equipment –

- Improves equipment maintenance efficiency by monitoring the changes in liquid color.
- Assists equipment multifunctionality and work automation by an operation based on the color information of the detected object.
- Provides stable operation of equipment by detecting the objects by color.
- Can be built into equipment thanks to its compact form* and high degree of installation flexibility.

* Size: 8.4 [W] × 40 [L] × 15.9 [H] mm



 Be sure to read Safety Precautions on page 5.

Model Number Legend

B5WC-VB -
 1. 2. 3. 4. 5.

1. Size

2: Miniature

2. Sensing distance

3: 40 mm

3. Output

2: I²C

4. Protective structure

2: IP50

5. Minimum number of deliverable units

1: 1 piece

Ordering Information

Sensors

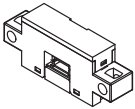
Sensing method	Appearance	Size	Connecting method	Output type	Sensing distance	Model	Minimum number of deliverable units (Unit: pieces)
Reflective		Miniature	Connector	I ² C	40 mm	B5WC-VB2322-1	1

B5WC

Ratings and Specifications

Item	Model	B5WC-VB2322-1
Sensing distance		40 mm (white paper)
Light source		White LED
Power supply voltage		5 VDC \pm 5%
Current consumption		18 mA max. (at 5.25 VDC)
Communication method		I ² C
I ² C output		Output voltage value for each of red, green and blue: 0.45 V \pm 20% (when gray reference plate and detection distance of 40 mm) Output saturation voltage: Typ. 2.75 V (output voltage range: 0 to 2.75 V) SCL/SDA input H voltage: 2.54 to 5.4 V, input L voltage: 0.9 V max., SDA output L voltage 0.44 V max. (when output current of 3 mA) RGB output voltage value resolution: 3.2 mV
Sampling period		1 msec
Data update period		Sampling period (1 msec) \times average number of times (1 to 50 times)
Ambient temperature range		Operating: -10 to +70°C, Storage: -25 to +80°C (with no icing or condensation)
Vibration resistance		10 to 55 Hz, 1.5-mm double amplitude for 2 h each in X, Y, and Z directions
Shock resistance		150 m/s ² for 3 times each in X, Y, and Z directions
Degree of protection		IEC IP50 (not including terminals)
Connecting method		Connector models (connector: SM05B-SRS made by J.S.T. Mfg. Co., Ltd.)
Weight		Approx 3.4 g
Material	Case	Polycarbonate (PC)
	Lens	Acrylic (PMMA)
	Cover	Polycarbonate (PC)

Output Circuit Diagram

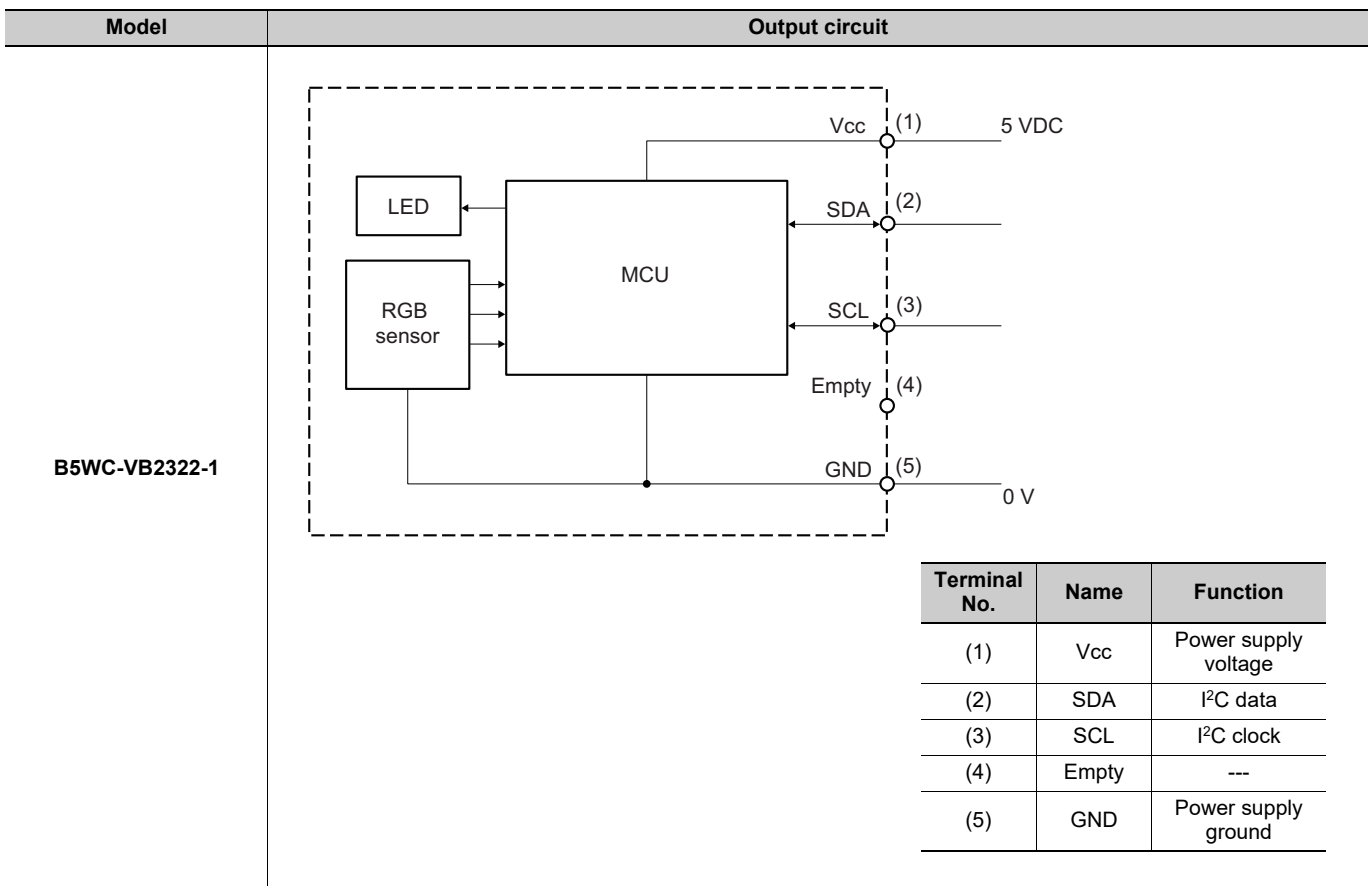

Engineering Data (Reference Value)

Output voltage ratio: This indicates each RGB output voltage ratio with the highest signal within the RGB output voltages expressed as 100%.
 Example: Red = 1.0 V, Green = 0.7 V, Blue = 0.5 V => Red: 100%, Green: 70%, Blue: 50%

Munsell color detection capacity

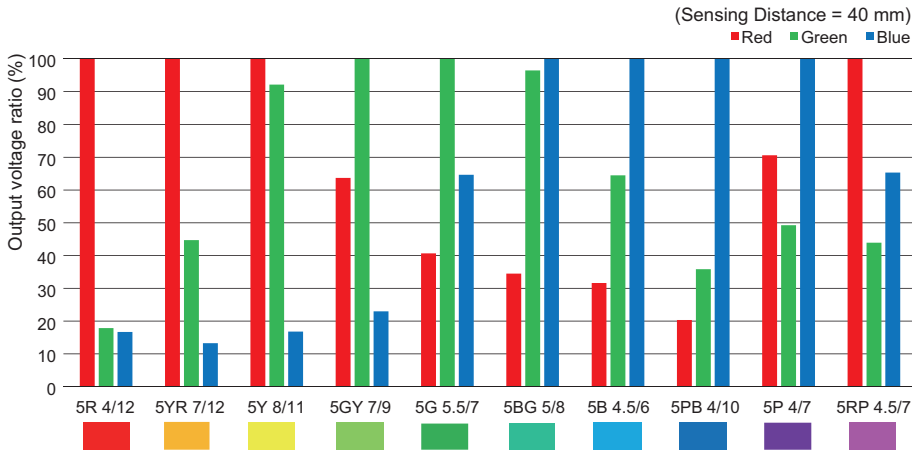

ASTM color detection capacity

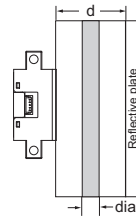
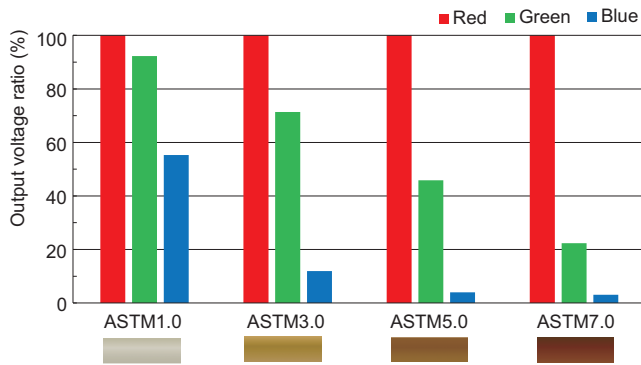

d=22 mm
 dia.=7 mm
 Reflective plate: Stainless steel 430
 Detected object: ASTM reagent

Receiver Output - Sensing Distance Characteristics

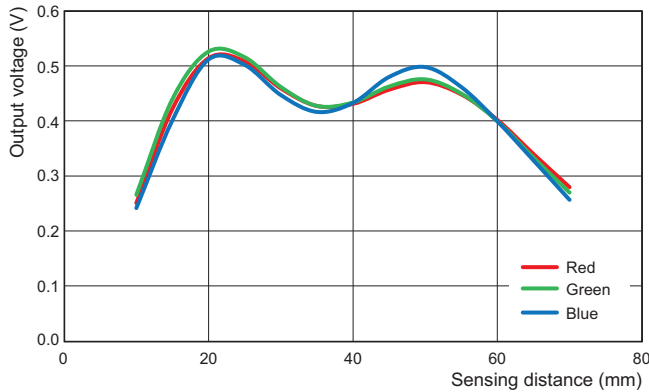

Receiver output ratio - Sensing Distance Characteristics

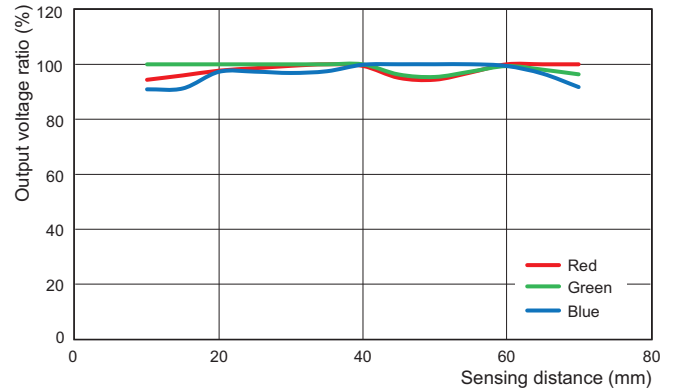

Receiver Output - Angle characteristics (Up and down)

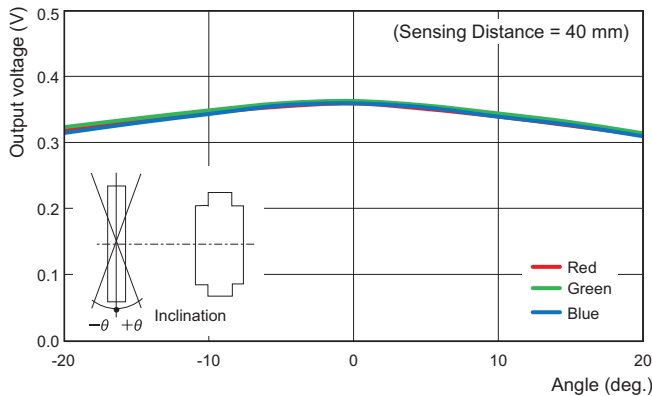

Receiver output ratio - Angle characteristics (Up and down)

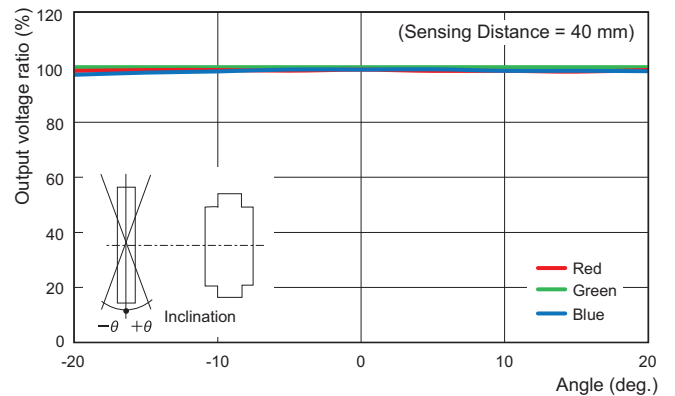

B5WC

Engineering Data (Reference Value)

Output voltage ratio: This indicates each RGB output voltage ratio with the highest signal within the RGB output voltages expressed as 100%.
 Example: Red = 1.0 V, Green = 0.7 V, Blue = 0.5 V => Red: 100%, Green: 70%, Blue: 50%

Receiver Output - Angle characteristics (Left and right)

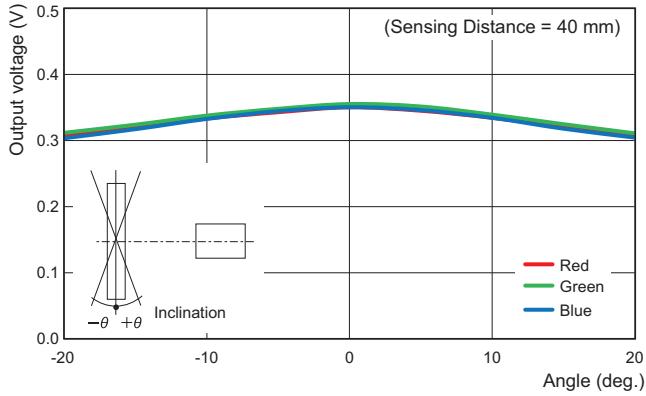

Receiver output ratio - Angle characteristics (Up and down)

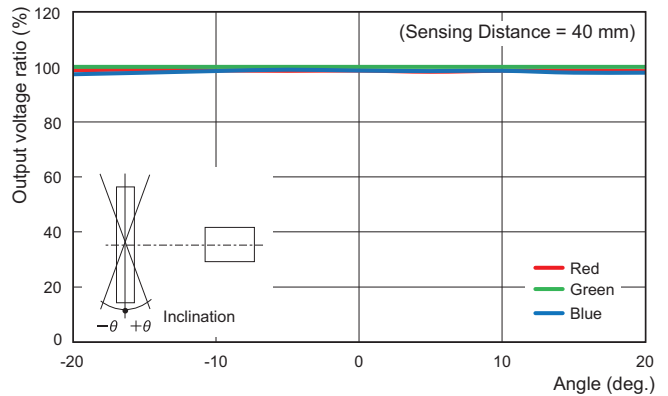

Dimensions

(Unit: mm)
 Tolerance class IT16 applies to dimensions in this data sheet unless otherwise specified.

B5WC-VB2322-1

CAD Data

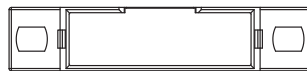
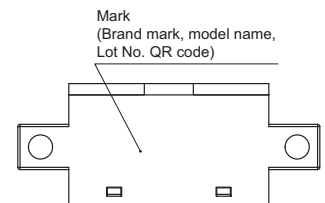
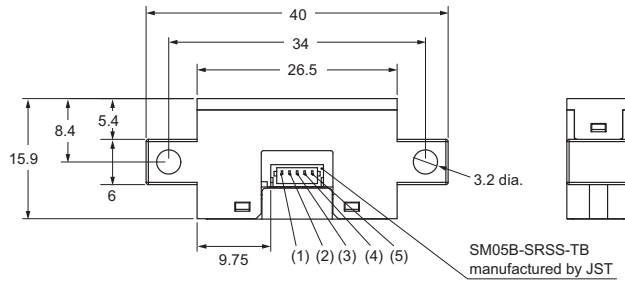
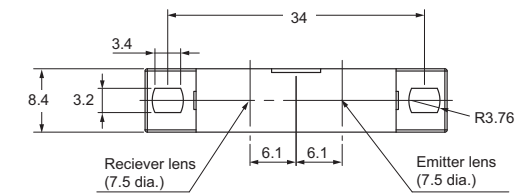
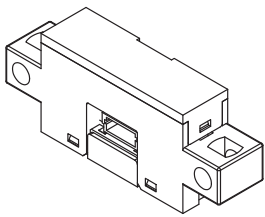

Terminal No.	Name
(1)	Vcc
(2)	SDA
(3)	SCL
(4)	Empty
(5)	GND

Safety Precautions

To ensure safe operation, be sure to read and follow the Terms and Conditions Agreement.

⚠ WARNING

These products cannot be used in safety devices for presses or other safety devices used to protect human life. This product is designed for use in applications for sensing workpieces and workers that will not affect levels of safety.



⚠ CAUTION

This product is not designed or rated for ensuring safety of persons either directly or indirectly. Do not use it for such purposes.



Precautions for Safe Use

To ensure safety, observe the following precautions.

● Wiring

Power supply voltage

Do not use the product with a voltage or current that will even momentarily exceed the specified voltage or current range. Applying a voltage or current exceeding the specified voltage or current range or using an AC power supply may result in rupture or burning.

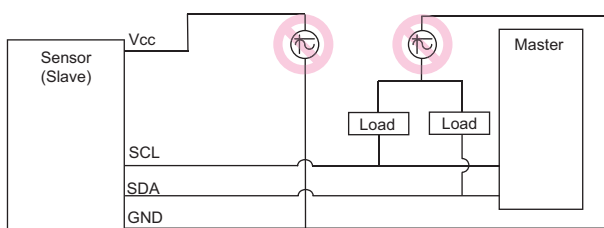

Load Short-circuit

Do not short-circuit the load. Rupture or burning may occur.

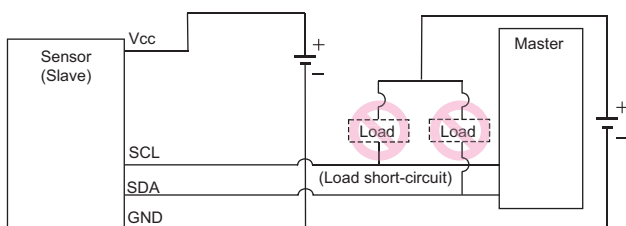

Faulty Wiring

Do not miswire such as the polarity of the power supply voltage. Rupture or burning may occur.

Example 1. Wrong polarity

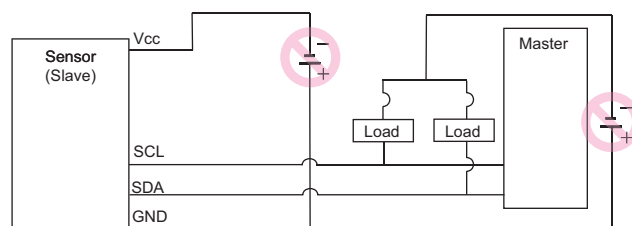

Example 2. Wrong polarity and faulty wiring

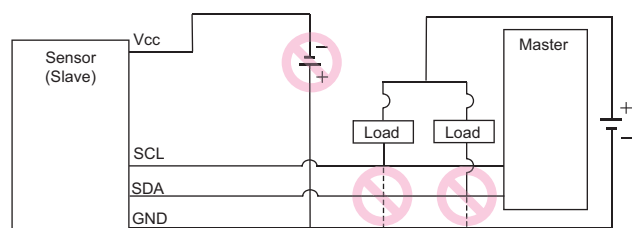

Connection without Load

If the power supply is connected directly without a load, rupture or burning of the internal elements may occur. Connect a load when wiring.

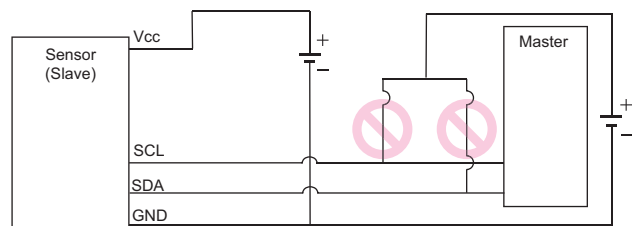

Storage and Operating Environment

1. Places where the product is not exposed to corrosive gases, such as hydrogen sulfide gas, or salty wind.
2. Places where it is not exposed to direct sunlight.
3. Make sure that flux, oil, or other chemicals do not adhere to the surface of the emitter and receiver.
4. Do not apply a load that may deform or deteriorate the product in any circumstances.
5. Store the product in a normal temperature, humidity, and pressure environment.
6. The product should be used without freezing or condensation.
7. Do not use the product in atmospheres or environments that exceed product ratings.
8. This product does not have a water-proof and oil-proof structure. Therefore, do not use the product in an application or environment where it will be subject to water, oil, chemicals, or any other liquid getting directly on it.

Precautions for Correct Use

● **Mounting**

1. This sensor is designed to be built into equipment. Design the equipment structure so that ambient light does not enter into the sensor. When using the equipment where the sensor will be influenced by ambient light, install it so that the sensor will not be affected by ambient light.
2. Mount the sensor securely on a flat surface.
3. Take care that nothing comes into contact with the detected part of the sensor. Damage to the sensing element will result in poor performance.
4. Before using the sensor, check to make sure that it has not become loose due to vibration or shock.
5. When using the sensor with a moving part, secure the part of the cable that is pulled out so that stress will not be directly applied to it.

● **Wiring**

Surge Prevention

1. If there is a surge in the power supply, try connecting a Zener diode or a capacitor (with a capacitance of 0.1 to 1 μF), depending on the operating environment. Use the sensor only after confirming that the surge has been removed.

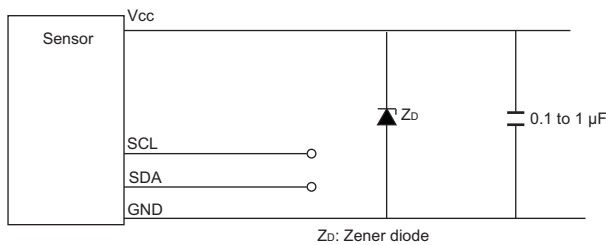

2. Do not use a small inductive load, such as a relay.
3. Separate the wiring for sensors from high-voltage lines or power lines. If the wiring is routed in the same conduit or duct as such lines, the sensors may malfunction or may be damaged by inductive interference.
4. When attaching the connectors, make sure that they are inserted into the housing properly.

● **Handling during Wiring**

Surge Prevention

1. If a force is applied to the connection area between the terminal and connector by bending or pulling the cable after the wiring is completed, the connector contact part or connection area with the cable may be damaged, resulting in contact failure. Make sure that a stress (external force) as shown in the figure below is not applied to the connection area between the terminal and connector when routing and connecting cables or harnesses.
2. Do not perform cord wiring when power supply voltage is applied. Doing so may result in breakage.

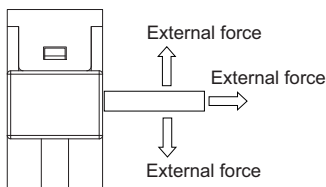

● **Design**

Modulated-light sensors

When designing, give proper consideration to the influence of the power supply and cable length. Since this sensor is a modulated-light sensor, it is more easily affected than non-modulated light sensors.

Reasons for Interference from Power and Cable Length on the sensors with Modulated Light

An LED emitter is pulse-lighted to produce modulated light. A large current momentarily flows to the sensor in sync with this pulse timing. This causes a pulsating consumption current. A photoelectric sensor incorporates a capacitor with sufficient capacity, and is virtually unaffected by the pulse of the consumption current. With a small sensor, however, it is difficult to have a capacitor with a sufficient capacity. Accordingly, when the cable length is long or depending on the type of power source, it may become impossible to keep up with the pulse of the consumption current and operation may become unstable.

Countermeasures

Adding a Capacitor

Attach a capacitor of 10 μF min. as close as possible to the sensor when wiring. (Use a capacitor with a dielectric strength that is at least twice the sensor's power supply voltage. Do not use tantalum capacitors. A short-circuit may cause the capacitor to ignite due to the large current flow.)

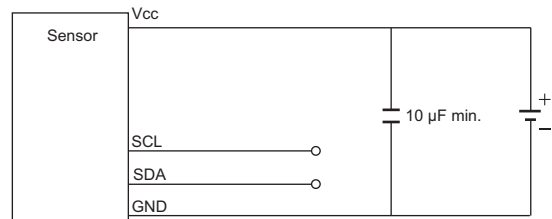

Countermeasures for Switching Power Supplies

Take either of the following countermeasures as required if connecting a modulated-light sensor to a switching power supply.

1. Attach a capacitor (e.g., aluminum electrolytic capacitor) of 10 μF min. as close as possible to the sensor when wiring.
(Use a capacitor with a dielectric strength that is at least twice the sensor's power supply voltage. Do not use tantalum capacitors. A short-circuit may cause the capacitor to ignite due to the large current flow.)

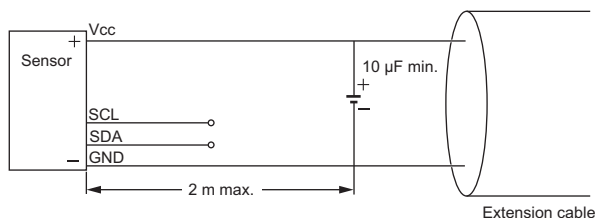

2. Connect to the 0-V line of the power source or connect by way of a capacitor (approx. 0.47 μF) at the point closest to the sensor to reduce the impedance of the sensor mounting base so that it is difficult for inductive noise to enter the mounting base.

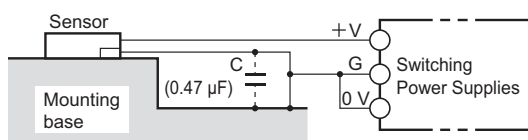

3. Connect the noise filter terminal (neutral terminal to ACG) of the switching power supply to the case (FG) and 0-V terminal of the power supply.
The line connected as mentioned above should be grounded or connected to the mounting base to ensure stable operation.
(Recommended by power supply manufacturers.)

Countermeasures to Handle Inductive Noise

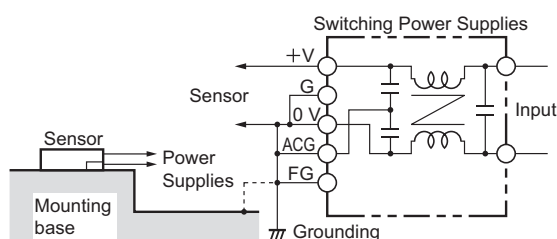

Insert a plastic insulator of approximately 10 mm between the sensor and the mounting base.

Effects of Inductive Noise

When there is inductive noise in the sensor mounting frame (metal), the output of the sensor may be affected.

In this case, ensure that there is no electrical potential difference between the sensor 0-V terminal and the sensor mounting frame (metal).

Or, put a 0.47- μF capacitor between the 0-V terminal and the frame.

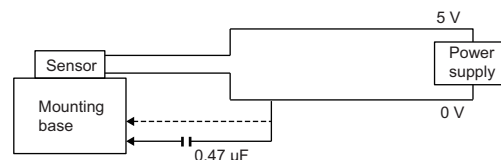

Other precautions

1. Do not mount the sensor in the following places because doing so may cause malfunction or failure.
 - 1) Place exposed to a lot of dust or oil mist
 - 2) Place exposed to a lot of corrosive gas
 - 3) Place directly or indirectly exposed to splashes of water, oil, or chemicals
 - 4) Outdoors or place exposed to intensive light such as direct sunlight
2. The sensor may be dissolved by exposure to organic solvents, acid, alkali, aromatic hydrocarbon, and chlorinated aliphatic hydrocarbon solvents, causing deterioration in the characteristics. Do not expose the sensor to such chemicals.
3. An output pulse may occur when the power supply is turned ON due to the power supply environment and other influences. Use the sensor in the stable ready-for-detection state reached in 100 ms after turning on the power supply.
4. When the number of averaging times is set to a low value, variations in the RGB output values may increase due to A/D conversion errors, noise, and other factors. We recommend checking the RGB output values multiple times.
5. If the sensor is used outside the power supply voltage range, set the power to OFF (0 V) once because there is the possibility of unexpected operation.
6. If foreign matter has adhered to the lens, the output voltage may vary. When removing foreign matter from the lens, take care not to touch the lens with a hand, etc. so as to prevent it from getting scratched or dirty.
7. Use a power supply of max. 15 W for the power supply connected to this sensor because the internal circuit does not have a safety device.

Please check each region's Terms & Conditions by region website.

OMRON Corporation
Device & Module Solutions Company

Regional Contact

Americas

<https://components.omron.com/us>

Asia-Pacific

<https://components.omron.com/ap>

Korea

<https://components.omron.com/kr>

Europe

<https://components.omron.com/eu>

China

<https://components.omron.com.cn>

Japan

<https://components.omron.com/jp>